

AUTHORIZED SERVICE CENTERS

NORTHWEST REGION

WARN INDUSTRIES, 12900 S.E. CAPPS ROAD, CLACKAMAS, OR 97015
503-722-1200, 800-543-WARN, 503-722-3000 (FAX)

730 NORTH CENTRAL, KENT, WA 98032
253-852-2720, 800-962-1463 (NATIONAL), 253-852-2796 (FAX)

3711 EAST TRENT, SPOKANE, WA 99202
509-535-7671, 800-541-4320 (NATIONAL), 509-535-9105 (FAX)

2138 CENTURY WAY, BOISE, ID 83709
800-635-3702 (NATIONAL), 800-632-2006 (IN STATE),
208-377-9393, 208-377-9437 (FAX)

1884 EAST 3RD AVE, ANCHORAGE, AK 99501,
907-278-6622, 907-278-6625 (FAX)

44113 K BEACH ROAD, SOLDATNA, AK 99669
907-260-9177, 907-260-9194 (FAX)

WESTERN REGION

3530 EAST WASHINGTON ST, PHOENIX, AZ 85034
602-273-7195, 800-606-6421 (NATIONAL), 602-225-0751 (FAX)

850 COMMERCE STREET, REDDING, CA 96002
530-221-6063, 877-223-8906 (NATIONAL), 530-221-6173 (FAX)

1143 WEST 2ND ST., POMONA, CA 91766
909-623-3373, 909-469-4685 (FAX)

ROCKY MOUNTAIN REGION

1101 N. COLLEGE AVENUE, FT. COLLINS, CO 80524
970-482-5500, 970-482-9576 (FAX)

4260 NORTH NEVADA AVE, COLORADO SPRINGS, CO 80907
719-528-5790, 719-531-0130 (FAX)

247 WEST 1700 SOUTH, SALT LAKE CITY, UT 84115
801-488-4666, 800-453-5703 (NATIONAL), 801-488-4676 (FAX)

522 MONTANA AVE., LIBBY, MT 59923
406-293-8661, 877-463-2344 (NATIONAL), 406-293-9511 (FAX)

MIDWEST REGION

5711 WEST 36TH STREET, ST. LOUIS PARK, MN 55416
952-927-8811, 800-622-0781 (IN STATE),
800-328-4445 (NATIONAL), 952-927-4500 (FAX)

#24 SCHIBER CT., MARYVILLE, IL 62062
618-288-7470, 877-437-4294 (NATIONAL), 618-288-7370 (FAX)

SOUTHWEST REGION

6025 CORRIDOR PARKWAY, SCHERTZ, TX 78154
210-651-2000, 800-374-8028 (NATIONAL), 210-651-2020 (FAX)

SOUTHERN REGION

6601 I-30, LITTLE ROCK, AR 72209
501-568-9000, 800-568-9006 (NATIONAL), 501-568-7000(FAX)

NORTHEAST REGION

815 HELLAM STREET, WRIGHTSVILLE, PA 17368
717-252-3602, 800-827-1341 (NATIONAL), 717-252-2296 (FAX)

23308 AIRPARK DR, PETERSBURG, VA 23803
804-861-1076, 800-572-2886 (IN STATE), 804-861-6891(FAX)

SOUTHEAST REGION

HWY 123 SOUTH, CLEMSON, SC 29633
864-882-0277, 800-257-4294 (NATIONAL), 864-882-0278 (FAX)

7779 DIXIE HIGHWAY, LOUISVILLE, KY 40258
502-935-5501, 800-626-6532 (NATIONAL), 502-933-5980 (FAX)

4700 RANGELINE RD, MOBILE, AL 36619
251-666-8606, 800-633-6946 (NATIONAL), 251-666-8676 (FAX)

5100 SUMMIT RIDGE, TUSCALOOSA, AL 35405
205-344-5203, 205-553-4676 (FAX)

2265 WEST BEAVER STREET, P.O. BOX 6307, JACKSONVILLE, FL 32236
904-354-5691, 800-741-0603 (NATIONAL), 904-354-8346 (FAX)

6501 ADAMO HWY 60, TAMPA, FL 33619
813-623-6713, 800-771-6713 (NATIONAL), 813-621-1741 (FAX)

4455 DARDANELLE DR, ORLANDO, FL 32808
407-291-1441, 800-226-0002 (NATIONAL), 407-578-7455 (FAX)

917 NW 1ST ST., FT. LAUDERDALE, FL 33311
954-463-7711, 800-972-7804 (NATIONAL), 954-764-6645 (FAX)

5625 SW 6TH PL., OCALA, FL 34474
352-861-8006, 866-267-8006 (NATIONAL), 352-861-8204 (FAX)

7310 NW 46TH ST., MIAMI, FL 33166
305-592-8612, 866-592-8612 (NATIONAL), 305-477-7012 (FAX)

1410 COMMERCE BLVD, SARASOTA, FL 34243
941-360-2490, 866-360-2490 (NATIONAL), 941-360-2449

CANADA

1665 SHAWSON DRIVE, MISSISSAUGA, ONTARIO L4W 1D7
905-564-5800, 800-668-6012 (CANADA ONLY), 905-564-5799 (FAX)

900 MONTEE-DE-LIESSE, ST-LAURENT, (MONTRÉAL) QUÉBEC H4T 1N8
514-856-0407, 800-361-9291(NATIONAL), 514-856-0636 (FAX)

4311-122 AVE SE, CALGARY, ALBERTA T2Z 4J3
403-720-8033, 800-267-0559(NATIONAL), 403-720-8040 (FAX)

18073- 107 AVENUE, EDMONTON, ALBERTA T5S 1K3
780-483-7867, 800-661-7335 (NATIONAL), 780-484-5814 (FAX)

19150- 96 AVENUE, SURREY, BRITISH COLUMBIA V4N 3R3
604-888-4464, 800-473-1717 (NATIONAL), 604-888-2029 (FAX)

144 ILSLEY AVE, DARTMOUTH, N.S. B3B 1V1
902-468-8288

17861-106A, EDMONTON, AB T5S 1V8
780-451-0030, 780-451-3116 (FAX)

1594 NICHOLSON STREET, PRINCE GEORGE, BC V2N 1V6
250-562-6760, 250-562-3407 (FAX)

210 S.W. MARINE DR., VANCOUVER, BC V5X 2R5
604-291-7512 , 866-888-7512 (NATIONAL), 604-324-4800 (FAX)



Warn Industries, Inc.
12900 S.E. Capps Road
Clackamas, OR USA 97015-8903
1-503-722-1200 Fax: 1-503-722-3000

Customer Service: 1-800-543-9276

Dealer Locator Service: 1-800-910-1122

International Sales Support: 1-503-722-3008

International Fax: 1-503-722-3005

www.warn.com

The dealer locator
service is 7 days per
week and 24 hours a day.

Please call between 7:00
am and 4:00 pm Pacific
Time, Monday through
Friday.

DISTRIBUTED BY:

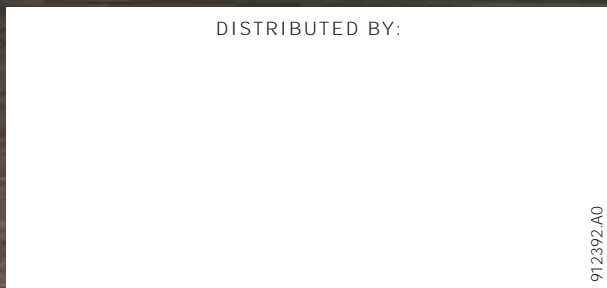

912392.A0

APPROVED WARN ATV DEALER NETWORK

A unique group of ATV dealers that offer consumers excellent product information, availability and service for WARN ATV products. To find one near you, go to the WARN website www.warn.com

Specifications subject to change at any time.
"WARN" is a trademark of Warn Industries, Inc.
© Warn Industries, Inc. 2007
Printed in USA Printed in USA 50M 02/07 GAC

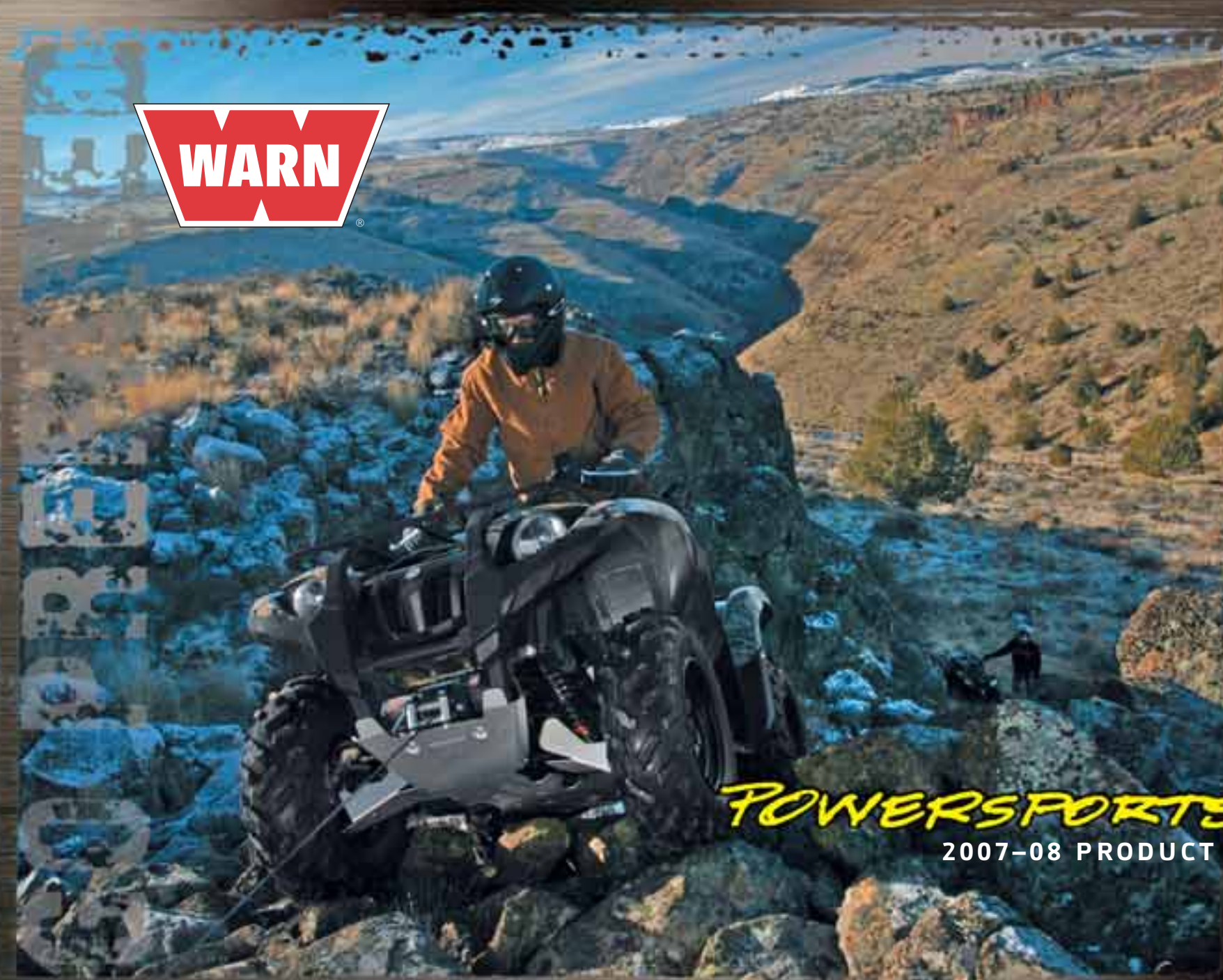

POWERSPORTS

2007-08 PRODUCT GUIDE



GO PREPARED™

WHAT'S NEW FOR 2007

- **XT EXTREME TERRAIN AND RT RUGGED TERRAIN POWERSPORTS WINCHES:** The best winches just got better. Page 3
- **WIRELESS CONTROL SYSTEM:** For winch operation with no strings (or wires) attached. Page 14
- **ATV AND UTV BODY ARMOR:** Protect your vehicle where it needs it most with our skid plates, UTV Rock Sliders, and UTV Bumpers. Page 24
- **UTV LIGHT BAR:** Mount up to four 6" lights on your UTV's roll bar. Page 32
- **OFF-ROAD LIGHTS:** 4X Flood, SDB-160 Dual Beam, and powerful 200,000 candlepower H.I.D. lights. Page 32
- **POWER-PIVOT:** Rotate your plow blade up to 25° at the push of a button. Page 26



WARN INDUSTRIES KNOWS HOW YOU USE POWERSPORTS VEHICLES, SO WE'VE DEVELOPED PRODUCTS AND ACCESSORIES TO HELP YOU AND YOUR VEHICLE GO FARTHER AND DO MORE. WHETHER YOU RIDE HARD ON THE TRAIL, OR WORK HARD IN THE FIELD, WARN INDUSTRIES MAKES PRODUCTS THAT ALLOW YOU TO GET THE MOST OUT OF YOUR ATV, UTV, OR SNOWMOBILE. WITH NEARLY 50 YEARS OF BUSINESS EXPERIENCE, WORLD-CLASS QUALITY, AND INDUSTRY-LEADING DESIGN INNOVATIONS, YOU CAN BE SURE WARN INDUSTRIES MAKES THE BEST POWERSPORTS PRODUCTS ON THE MARKET.



WINCHES: 2-13



WINCH ACCESSORIES: 14-16



MOUNTING SYSTEMS, BUMPERS AND BODY ARMOR: 17-25



PLOWS: 26-31



LIGHTS: 32



424 SELECT AND TRUCK/UTILITY PRODUCTS: 33

WARN POWERSPORTS WINCHES

OUT HERE, YOU'LL BE GLAD YOU WENT WITH WARN

INTRODUCING THE WARN XT AND RT WINCH SERIES

The new line of WARN® Powersports winches lets you ride with confidence knowing that when you need to pull yourself out of the muck or move a heavy load, you'll be up to the task time and time again.

THIS NEW LINEUP MAKES THE BEST WINCHES IN THE WORLD EVEN BETTER.

The new XT Extreme Terrain and RT Rugged Terrain winches are designed specifically for powersports vehicles with standard features like weather-resistant sealed construction; rugged and reliable 3-stage planetary geartrains; patent-pending disc brakes to prevent rollback; efficient electrical systems for less battery drain; easy-to-use clutch dials; and legendary WARN quality. You can be assured our winches are the best on the market. We're so sure they're the best, we've added a limited lifetime warranty to every WARN ATV and UTV winch and backed it with a world-wide service organization.



PERMANENT MAGNET MOTOR FOR PLENTY OF PULLING MUSCLE

PATENT-PENDING DISC BRAKE HOLDS YOU ON THE HILLS AND PREVENTS ROLLBACK

FULLY SEALED TO KEEP THE ELEMENTS OUT

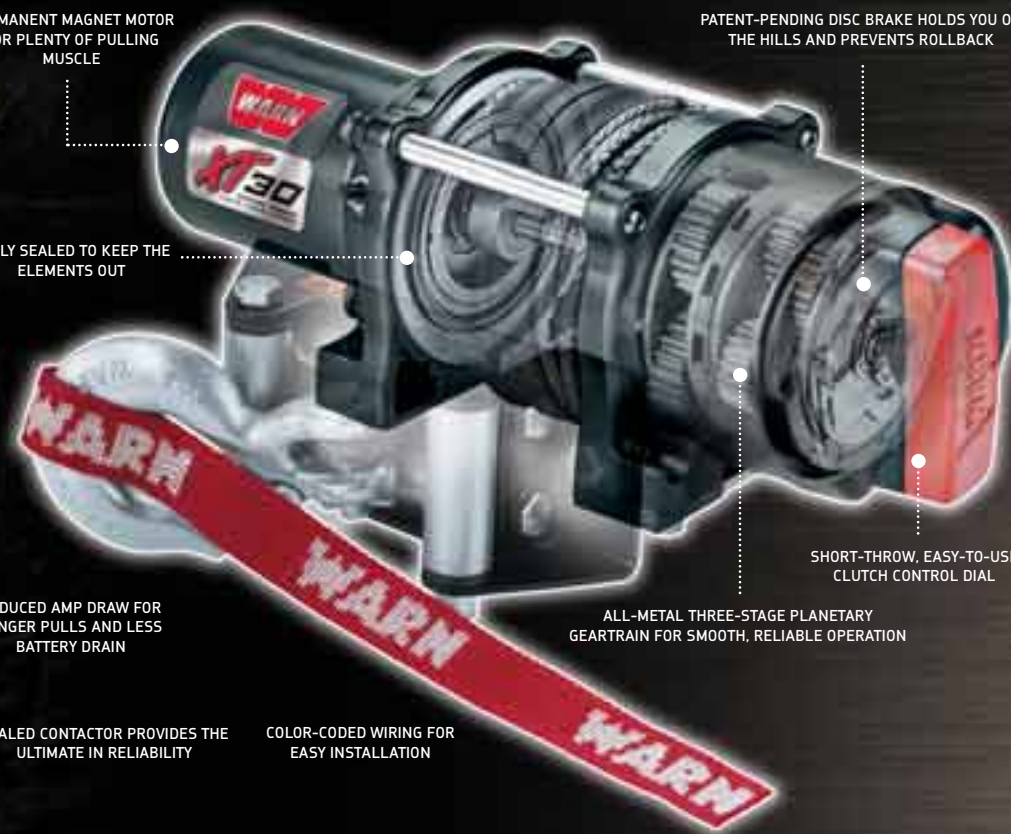

REDUCED AMP DRAW FOR LONGER PULLS AND LESS BATTERY DRAIN

ALL-METAL THREE-STAGE PLANETARY GEARTRAIN FOR SMOOTH, RELIABLE OPERATION

SEALED CONTACTOR PROVIDES THE ULTIMATE IN RELIABILITY

COLOR-CODED WIRING FOR EASY INSTALLATION

XT AND RT: BECAUSE NOT ALL RIDERS ARE THE SAME

XT EXTREME TERRAIN

For the rider who pushes the envelope and loves to tackle the toughest trails and deepest mud, WARN has developed the XT, or Extreme Terrain winch series. All XT winches come with synthetic rope for light weight and easy handling, making them perfect for ATV recovery.



RT RUGGED TERRAIN

If you're the person who depends on their vehicle in the field or on the job, then an RT, or Rugged Terrain winch may be for you. The RT series' durable aircraft-grade wire rope will get the job done whether you're moving a downed tree, pulling that prize elk out of the field, or recovering a vehicle.



GO PREPARED™

XT

EXTREME TERRAIN



THE WARN XT EXTREME TERRAIN WINCH SERIES IS FOR THE EXTREME RIDER WHO TAKES THE TRAIL LESS TRAVELED AND RIDES ON THE EDGE. WITH A TON OF STANDARD FEATURES INCLUDING LIGHTWEIGHT, EASY-TO-HANDLE SYNTHETIC ROPE AND AN AVAILABLE WIRELESS CONTROL SYSTEM, THE XT WINCHES HAVE THE FEATURES THE MOST DEMANDING RIDERS WANT.



If you're someone who uses a winch to lift your plow, you'll also want an XT winch. The XT's flexible synthetic rope withstands the sharp bends that can damage wire rope, and will provide excellent durability.

WARN XT30

TACKLE THE TRAIL WITH THE ULTIMATE ATV WINCH FOR THE MOST DEMANDING RIDER.



FOR LARGE-BORE UTILITY ATVS, 500CC AND LARGER

When you want the top-of-the-line ATV winch, you'll want the XT30. With features like our patent-pending Wireless Control System and 3,000 lb. line capacity, you'll be able to pull the biggest ATVs out of the muck from anywhere within a 50' radius. When your vehicle gets stuck, you'll be glad you have the XT30's lightweight, easy-to-handle synthetic rope, which is also great for plow lifting. Full sealing will keep the elements out and an all-metal 3-stage planetary geartrain will keep the winch running smoothly for years. And when the hills get steep, the winch's confidence-inspiring, patent-pending disc brake will hold you securely so you don't roll back. **PN 76500**

- WIRELESS CONTROL SYSTEM FOR INCREASED VERSATILITY WHEN WINCHING, PLUS A SEALED HANDLEBAR-MOUNTED MINI-ROCKER CONTROL SWITCH
- 50' (15M) OF LIGHTWEIGHT, EASY-TO-HANDLE 3/16" DIAM. (5MM DIAM.) SYNTHETIC ROPE.
- FULLY SEALED TO PROTECT AGAINST THE ELEMENTS
- ALL-METAL 3-STAGE PLANETARY GEARTRAIN FOR SMOOTH, RELIABLE OPERATION
- PATENT-PENDING DISC BRAKE PREVENTS ROLLOVER
- REDUCED AMP DRAW FOR LONGER PULLS AND LESS BATTERY DRAIN
- 3,000 LB. (1,360 KG.) LINE CAPACITY TO PULL THE BIGGEST ATVS
- WEIGHT: 13.4 LBS. (6.1 KGS.)
- MOUNTING BOLT PATTERN: 3.0" X 4.88" (76MM X 124MM)
- OVERALL DIMENSIONS: 13.12" L X 4.51" D X 4.69" H (33.3CM L X 11.5CM D X 11.9CM H)

FOR UTILITY ATVS
300CC AND LARGER

WARN XT25

PUSH THE LIMITS AND
RIDE WITH CONFIDENCE
USING THIS
VERSATILE WINCH.



You can hit the trail with confidence when you've got the premium XT25. Its lightweight, easy-to-handle synthetic rope is great for pulling an ATV out of a sticky situation, and the rope's flexibility is perfect for plow lifting. The XT25 comes with a sealed handlebar-mounted mini-rocker switch for convenient winch control, and its fast line speed means you'll be out of trouble and back on the trail in a hurry. There's no reason to worry about rollback either, thanks to our patent-pending disc brake. Full sealing protects the XT25 from the elements, and its dependable all-metal 3-stage planetary geartrain and efficient electrical system provide long, powerful pulls with less battery drain. **PN 75500**

WARN XT15

THE PERFECT
LIGHTWEIGHT WINCH
FOR EXTREME
TERRAIN.



The XT15 has a 1,500 lb. pulling capacity and lightweight, easy-to-handle synthetic rope, making it perfect for recovering a stuck sport quad, small ATV, or lifting a plow blade. With standard features such as a patent-pending disc brake to prevent rollback, a 3-stage planetary geartrain for reliability, a sealed motor to keep the elements out, and a handlebar-mounted mini-rocker control switch, you can be sure you're getting a powerful, dependable winch that'll let you go prepared. **PN 78500**



FOR UTILITY ATVS
UNDER 300CC
AND SPORT QUADS



- 40' (12.2M) OF LIGHTWEIGHT, EASY-TO-HANDLE 5/32" (4MM) SYNTHETIC ROPE
- SEALED MOTOR FOR PROTECTION AGAINST THE ELEMENTS
- PATENT-PENDING DISC BRAKE PREVENTS ROLLBACK
- SEALED HANDLEBAR-MOUNTED MINI-ROCKER CONTROL SWITCH
- 3-STAGE PLANETARY GEARTRAIN FOR SMOOTH, RELIABLE OPERATION
- 1,500 LB. (680 KG.) LINE CAPACITY
- MOUNTING BOLT PATTERN: 3.0" X 4.88" (76MM X 124MM)
- WEIGHT: 8.6 LBS. (6.1 KGS.)
- OVERALL DIMENSIONS: 10.3" L X 4.0" D X 4.56" H (26CM L X 10CM D X 11.6CM H)



- 50' (15M) OF LIGHTWEIGHT, EASY-TO-HANDLE 3/16" (5MM) SYNTHETIC ROPE
- FULLY SEALED TO PROTECT AGAINST THE ELEMENTS
- ALL-METAL 3-STAGE PLANETARY GEARTRAIN FOR SMOOTH, RELIABLE OPERATION
- PATENT-PENDING DISC BRAKE PREVENTS ROLLBACK
- REDUCED AMP DRAW FOR LONGER PULLS AND LESS BATTERY DRAIN
- SEALED HANDLEBAR-MOUNTED MINI-ROCKER CONTROL SWITCH
- 2,500 LB. (1,134 KGS.) LINE CAPACITY TO PULL LARGER ATVS
- MOUNTING BOLT PATTERN: 3.0" X 4.88" (76MM X 124MM)
- WEIGHT: 13.4 LBS. (6.1 KGS.)
- OVERALL DIMENSIONS: 13.12" L X 4.51" D X 4.69" H (33.3CM L X 11.5CM D X 11.9CM H)

RT

RUGGED TERRAIN

THE RT RUGGED TERRAIN SERIES OF WINCHES ARE MADE FOR THE PERSON WHO USES THEIR POWERSPORTS VEHICLE AS A TOOL TO GET A JOB DONE. FROM CLEARING A DOWNED TREE ON THE TRAIL OR MOVING A HEAVY LOAD ON THE FARM, TO PULLING THAT PRIZE DEER OUT OF THE FIELD OR GETTING TO A PRIME HUNTING SPOT – THE RT SERIES WINCHES ARE GOING TO HELP YOU GET THE JOB DONE.



WARN RT30

FOR BIGGER ATVS AND HEAVIER PULLING JOBS, THIS WINCH HELPS YOU GET THE JOB DONE IN THE FIELD AND ON THE TRAIL.



With a mammoth 3,000 lb. pulling capacity, 50' of durable aircraft-grade wire rope, and a convenient handheld remote, the RT30 has the features you need to get the job done in the field and on the trail. No matter what the situation, the RT30's full sealing means the winch is prepared to do battle against the elements, and its all-metal 3-stage planetary geartrain will provide countless years of smooth, reliable operation. The patent-pending brake prevents rollback and will hold your vehicle securely on inclines. A standard handheld wired remote and handlebar-mounted mini-rocker switch increase your winching options so you can get the job done right. **PN 76000**



RT30 winch kit for the Polaris Sportsman – fully pre-assembled and ready to go. PN 75630 (Handheld remote sold separately)

FOR LARGE-BORE UTILITY ATVS, 500CC AND LARGER



- TWO METHODS OF CONTROL – CORDED REMOTE AND HANDLEBAR-MOUNTED MINI-ROCKER SWITCH
- 50' (15M) OF DURABLE AIRCRAFT-GRADE 3/16" (5MM) WIRE ROPE
- FULLY SEALED TO PROTECT AGAINST THE ELEMENTS
- ALL-METAL 3-STAGE PLANETARY GEARTRAIN FOR SMOOTH, RELIABLE OPERATION
- PATENT-PENDING DISC BRAKE PREVENTS ROLLBACK
- REDUCED AMP DRAW FOR LONGER PULLS AND LESS BATTERY DRAIN
- 3,000 LB. (1,360 KG.) LINE CAPACITY TO PULL THE BIGGEST ATVS
- MOUNTING BOLT PATTERN: 3.0" X 4.88" (76MM X 124MM)
- WEIGHT: 15.6 LBS. (7.1 KGS.)
- OVERALL DIMENSIONS: 13.12" L X 4.51" D X 4.69" H (33.3CM L X 11.5CM D X 11.9CM H)

FOR UTILITY ATVS
300CC AND LARGER



WARN RT25

WORK OR PLAY – THIS WINCH IS EVERYTHING YOU NEED TO GET THE JOB DONE.



CE



- 50' (15M) OF DURABLE 3/16" (5MM) WIRE ROPE
- SEALED HANDLEBAR-MOUNTED MINI-ROCKER CONTROL SWITCH
- FULLY SEALED TO PROTECT AGAINST THE ELEMENTS
- PATENT-PENDING DISC BRAKE PREVENTS ROLLBACK
- REDUCED AMP DRAW FOR LONGER PULLS AND LESS BATTERY DRAIN
- ALL-METAL 3-STAGE PLANETARY GEARTRAIN FOR SMOOTH, RELIABLE OPERATION
- 2,500 LB. (1,134 KG.) LINE CAPACITY TO PULL MOST ATVS
- MOUNTING BOLT PATTERN: 3.0" X 4.88" (76MM X 124MM)
- WEIGHT: 15.6 LBS. (7.1 KGS.)
- OVERALL DIMENSIONS: 13.12" L X 4.51" D X 4.69" H (33.3CM L X 11.5CM D X 11.9 H)

This is the winch for you when you need 2,500 lbs. of rugged pulling power using durable wire rope. As the industry standard, this unit is great for pulling a heavy load or recovering a stuck ATV. Features include our patent-pending brake to hold you on steep inclines, a reliable all-metal 3-stage planetary geartrain, an efficient electrical system that allows for longer pulls with minimal battery drain, and a handlebar-mounted mini-rocker switch for great control. **PN 75000**

WARN RT15

THE BEST 1,500 LB. ATV WINCH TO GET THE JOB DONE RIGHT.



CE



- 50' (15M) OF AIRCRAFT-GRADE 5/32" DIAM. (4MM DIAM.) WIRE ROPE
- SEALED HANDLEBAR-MOUNTED MINI-ROCKER CONTROL
- SEALED PERMANENT-MAGNET MOTOR TO PROTECT AGAINST THE ELEMENTS
- PATENT-PENDING DISC BRAKE PREVENTS ROLLBACK
- 3-STAGE PLANETARY GEARTRAIN FOR SMOOTH, RELIABLE OPERATION
- 1,500 LB. (680 KG.) LINE CAPACITY
- HAWSE FAIRLEAD
- MOUNTING BOLT PATTERN: 3.0" X 4.88" (76MM X 124MM)"
- WEIGHT: 11.5 LBS. (5.2 KGS.)
- OVERALL DIMENSIONS: 10.3" L X 4.0" D X 4.56" H (26CM L X 10CM D X 11.6CM H)

With its versatile wire rope and strong 1,500 lb. pulling capacity, the RT15 is the perfect tool for sport quads and smaller ATVs. The RT15 has a three-stage planetary geartrain to ensure reliability, an efficient electrical system for less battery drain, a sealed motor that will keep the elements out, and a patent-pending disc brake to prevent rollback. All these features mean the RT15 will pull through for you time after time. Best of all, it has legendary WARN quality, so you can be assured you're buying the best lightweight winch on the market. **PN 78000**

FOR UTILITY ATVS UNDER
300CC AND SPORT QUADS

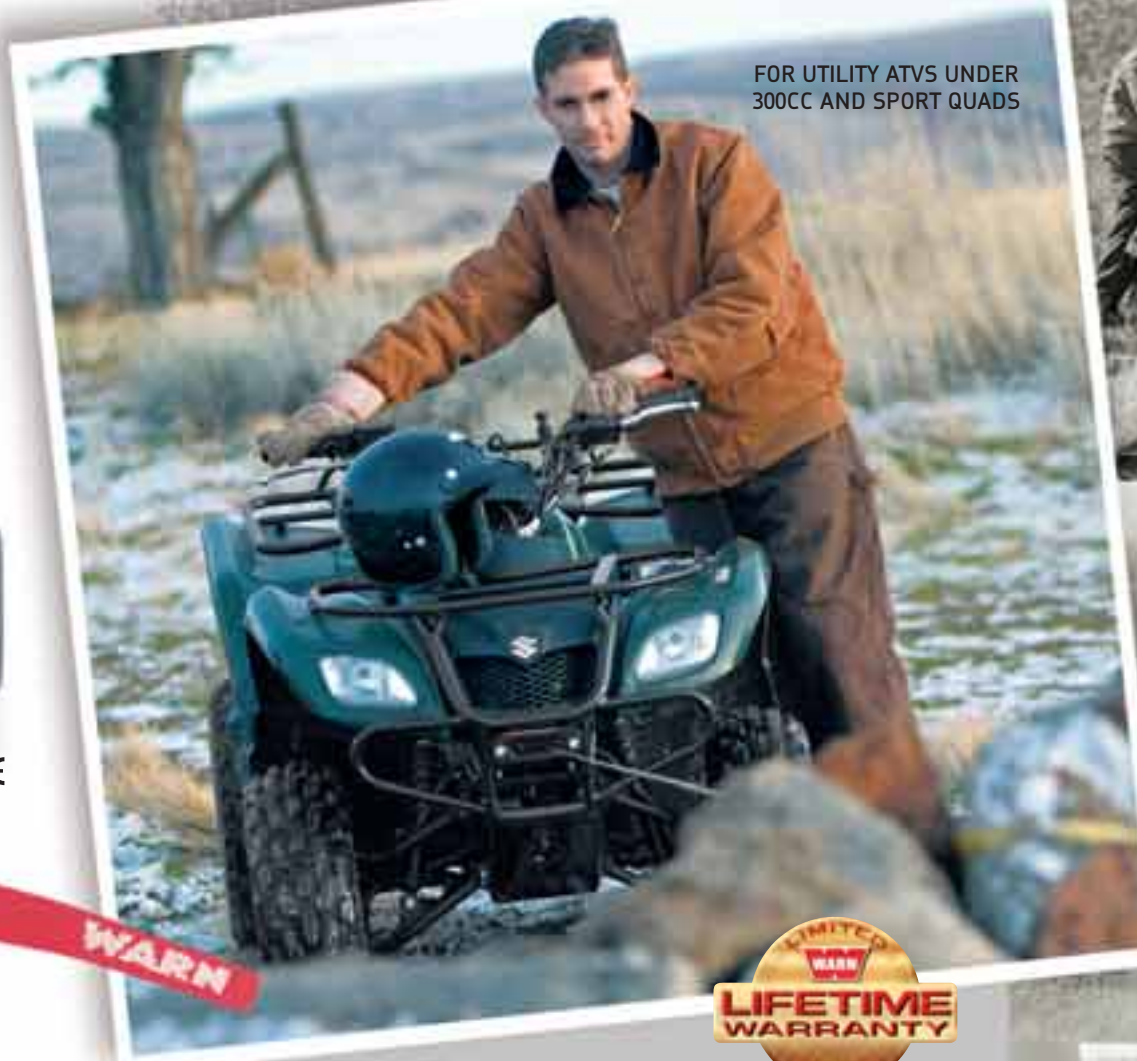

WARN RT40

OUTSTANDING PERFORMANCE FOR THE DEMANDS OF UTVs.



CE

SNOWINCH

PORTABLE WINCH SYSTEM FOR SNOWMOBILES.



SPECIFICALLY DESIGNED FOR SNOWMOBILES

SPECIFICALLY DESIGNED FOR UTVs



- THE LONGEST ROPE IN THE POWERSPORTS LINEUP: 55' (16.8M) OF 7/32" DIAM. (5.5MM DIAM.) AIRCRAFT-GRADE WIRE ROPE
- CORDED REMOTE AND MINI-ROCKER CONTROL WITH UNIVERSAL MOUNTING BRACKET FOR TWO METHODS OF CONTROL
- FULLY SEALED DRIVETRAIN TO KEEP THE ELEMENTS OUT
- PATENT-PENDING DISC BRAKE PREVENTS ROLLBACK
- ALL-METAL 3-STAGE PLANETARY GEARTRAIN FOR RELIABILITY AND SMOOTH OPERATION
- THE MOST POWERFUL PULLING CAPACITY IN THE WARN POWERSPORTS LINEUP: 4,000 LB. (1,814 KG.)
- MOUNTING BOLT PATTERN: 3.0" X 6.66" (76MM X 169MM)
- WEIGHT: 17.9 LBS. (8.1 KGS.)
- OVERALL DIMENSIONS: 14.42" L X 4.51" D X 4.69" H (36.6CM L X 11.5CM D X 11.9CM H)

When you need a winch for your UTV, look no further than the RT40: the first winch designed specifically for UTVs. The RT40 has a massive 4,000 lb. pulling capacity and the longest wire rope in the WARN Powersports winch lineup so you can pull heavier loads farther. This winch has tons of standard features including a patent-pending disc brake that securely holds the heaviest loads, a fully sealed drivetrain to guard against the elements, a reliable and smooth-running all-metal 3-stage planetary geartrain, a corded remote and a mini-rocker control, and an efficient electrical system for long pulls and less battery drain. This winch is ready to go to work, so you can get the most out of your UTV. **PN 77000**

This portable snowmobile recovery system packs 1,500 lbs. of pulling power to get your snowmobile back on the trail quickly. Setup is simple thanks to a Quick Connect plug that provides easy access to the battery power source, and an integrated mounting plate with fairlead and handle. The mechanical brake provides positive operator control when winching, and the rigging straps offer easy attachment to the carrier plate using carabineer-style hooks. SnoWinch comes with 40' of 5/32" synthetic rope that is durable and easy to handle; 9' and 25' recovery straps; and a handheld remote with a 10' lead for excellent control. The SnoWinch stores easily in a custom WARN bag when not in use and weighs just 15 lbs. **PN 70170**

- RATED LINE PULL: 1,500 LBS. (680 KGS.)
- MOTOR: 12V DC, 0.4HP PERMANENT MAGNET
- CONTROL: REMOTE CONTROL, 10 FT. (3.0M) LEAD
- GEARTRAIN: 3-STAGE PLANETARY
- GEAR RATIO: 103:1
- CLUTCH (FREESPOOLING): CAM ACTIVATED
- BRAKE: MECHANICAL BRAKE STANDARD
- DRUM DIAMETER/LENGTH: 1.5"/3.0"
- WEIGHT: 15 LBS. (7.0 KGS.)
- SYNTHETIC ROPE: 40', 5/32" DIAM. (13M, 4MM DIAM.)
- FAIRLEAD: SYNTHETIC HAWSE
- WARRANTY: 1-YEAR LIMITED



Storage bag conveniently holds winch and accessories



Quick-connect wiring provides easy access to battery power



Kit includes 40' synthetic winch rope and two rigging straps



Hooks and carrier plate connect winch to the sled



Hand-held remote control with 10' lead for full range of movement during winching



The SnoWinch is sold as a complete kit the includes everything you need to recover a snowmobile

WINCH ACCESSORIES

ESSENTIAL GEAR
TO MAKE YOUR WINCH
MORE PRODUCTIVE.

WIRELESS WINCH CONTROL SYSTEM CONTROL YOUR WINCH WITH NO STRINGS (OR WIRES) ATTACHED.

You spoke, WARN listened. This all-new Wireless Control System is designed from the ground up to suit your needs, and works with WARN® powersports winches. The system is quick and easy to install, thanks to a wiring harness with an integrated antenna, and all necessary mounting hardware.

The system allows you to operate your winch from anywhere within a 50' radius, increasing your recovery options. **PN 74500**

In the event you lose your WARN Wireless Control System transmitter, we offer this replacement unit. The easy-to-program remote is a direct replacement for the WARN Wireless Control System transmitter, and has easy-to-follow instructions for reprogramming your receiver to recognize the new transmitter. **PN 74520**



- WORKS WITH ANY WARN POWERSPORTS WINCH WITH A CONTACTOR AND MINI-ROCKER CONTROL SWITCH
- OPERATES YOUR WINCH FROM ANYWHERE WITHIN A 50' RADIUS
- WIRING HARNESS WITH BUILT-IN ANTENNA AND ALL NECESSARY HARDWARE ALLOWS FOR QUICK AND EASY INSTALLATION
- ACTIVATION PROCESS AND RECESSED BUTTONS PREVENT ACCIDENTAL WINCH ACTIVATION
- TWO COLOR LED INDICATES WHEN THE SYSTEM HAS POWERED ON (GREEN) AND WHEN THE SYSTEM HAS BEGUN WINCHING (RED). BLINKING RED LED INDICATES LOW BATTERY LIFE.
- SYSTEM AUTOMATICALLY POWERS OFF TO CONSERVE BATTERY LIFE
- RUGGED, WATERPROOF RECEIVER IGNORES INTERFERENCE FROM OTHER SIGNALS
- ERGONOMICALLY DESIGNED HANDHELD REMOTE HAS LARGE BUTTONS FOR EASY USE - EVEN WHEN WEARING GLOVES
- WORKS AT ALL VEHICLE VOLTAGE LEVELS THAT ALLOW WINCH OPERATION
- ALL COMPONENTS ARE WEATHERPROOF
- HANDLEBAR-MOUNTED HOLSTER KEEPS THE HANDHELD REMOTE AT THE READY

WINCHING ACCESSORY KIT

Double your pulling power, change your pulling direction and keep your winch in proper working order. The WARN Accessory Kit is essential gear for getting the most out of your WARN ATV Winch.

Accessory Kits include two shackles, snatch block, and two 1" x 8' (25.4mm x 2.4m) tree trunk protectors. Each kit comes in a black Cordura® heavyweight nylon soft case.

PN 69222 Kit with black nylon soft case

PN 63351 Black bag only



NEOPRENE WINCH COVER

Made of durable, tight-fitting neoprene that resists water and cracking.

PN 71072 (for RT/XT 15 series and 1.5ci)

PN 71980 (for RT/XT 25, 30 series and 2.5ci, 3.0ci winches)

PN 71975 (for RT40 and 4.0ci winches)



XT/RT15 winch cover includes 8' winch rigging strap



SNATCH BLOCK

Assists in double-lined and angled pulls. Rated to 7,000 lbs. (3,175 kgs) capacity and under.

PN 28881



SHACKLE

Shackle for rigging attachments. Rated to 4,000 lbs. (1,814 kgs) capacity and under.

PN 28884



TREE TRUNK PROTECTOR

1" x 8' (25.4mm x 2.438m) load strap, designed to protect a tree trunk from the damage a wire rope might cause. Designed for ATV use only. (Rated to 6,400 lbs.)

PN 28882



CHOKER CHAIN

10' (3m) chain allows a stable, sharp object to be used as a winch anchor.

PN 26083

BASIC GUIDE TO ATV WINCHING TECHNIQUES

Informative booklet helps you learn the important facts concerning the proper use of your winch. **PN 64660**



WARN WINCH UPGRADE KIT

Converts the WARN A2000 to the WARN 2.5ci ATV winch. Comes with the contactor, Express Install wiring and Mini-rocker switch control. **PN 63990**



REMOTE CONTROL UPGRADE KIT

Everything you need to add the versatile hand-held remote control to your RT/XT 25 series or RT/XT 15 series, 2.5ci or 1.5ci winches. Comes with remote control, socket and wiring (pictured above). **PN 64259**

REPLACEMENT REMOTE CONTROL

For WARN ATV winches (remote only—does not include socket). **PN 64849**

For the WARN SnoWinch **PN 70756**

REPLACEMENT WIRE ROPE

Aircraft grade wire rope, galvanized to help resist corrosion. Includes swaged loop on one end.

PN 60076 For RT 25, 30 series, 3.0ci, 2.5ci winches or A2500, A2000 winches with aluminum drum. 50', 3/16" diameter (15m, 5mm)

PN 15236 For A2500 or A2000 winches with steel drum. 50', 3/16" diameter (15m, 5mm)

PN 68851 For RT40, 4.0ci winches. 55', 7/32" diameter (16.8m, 5.5mm).

PN 69336 For RT15, 1.5ci winches. 50', 5/32" diameter (15m, 4mm diam).

REPLACEMENT MINI-ROCKER CONTROL SWITCH

Handlebar mounted control. Replacement part for the WARN RT/XT 15, 25, 30 series, 3.0ci, 2.5ci or 1.5ci ATV winches, or the WARN Plow Actuator control. Includes switch and mounting hardware.

PN 64851 For RT/XT 25, 30 series, 3.0ci or 2.5ci winches

PN 69206 For RT/XT 15 series or 1.5ci winches

PN 69660 For Plow Actuator

REPLACEMENT CONTACTOR

Weather resistant contactor handles high amps.

PN 65673 For RT40 or 4.0ci winches

PN 63070 For XT/RT 25, 30 series, A2500, 2.5ci or 3.0ci winches (pictured above)

PN 69281 For RT/XT 15 series or 1.5ci winches

PN 70755 For SnoWinch

ROLLER FAIRLEAD

Reduces excessive wear on your winch cable or wire rope and aids in angled pulls.

PN 28929 Replacement for RT/XT 25, 30 series, A2500, 2.5ci or 3.0ci winches. Upgrade from hawse fairlead on RT/XT 15 series, A2000 or 1.5ci winches

PN 29256 Replacement fairlead for RT40 or 4.0ci Utility Vehicle Winch.

ROLLER FAIRLEAD FOR ATV PLOW

Designed for use with winches that raise and lower the ATV plow blade. Larger diameter lower roller reduces wear on wire rope. **PN 69373**

HAWSE FAIRLEADS

Replacement part for the WARN RT/XT 15 series, A2000, 1.5ci or 2.5ci winches. Cast iron. **PN 28930**

Replacement part for the WARN SnoWinch. Built from synthetic material. **PN 70759**

WINCHING GLOVES

Essential for safe handling of wire rope. Constructed of cotton and leather, with silk screened WARN logo.

PN 14042

REPLACEMENT HOOK AND STRAP

WARN ATV hook with safety latch. Includes hook strap.

PN 39557



SYNTHETIC ROPE REPLACEMENT KIT

For use with all WARN ATV winches with aluminum drums. Includes synthetic rope, rock guard sleeve and roller fairlead.

PN 72495 RT15, 1.5ci winches- 40' of 5/32" diam.

PN 72128 RT 25, 30 series and 2.5ci, 3.0ci winches- 50' of 3/16" diam.

SNOWINCH ROPE REPLACEMENT KIT

For use with WARN SnoWinch. Includes synthetic hawse fairlead. 40', 5/32" diam. (13m, 4mm diam.) **PN 70758**



ATV SYNTHETIC ROPE EXTENSION

ATV riders can now extend the reach of their WARN winch with the new 50' WARN ATV Synthetic Rope Extension. The 1/4" diameter rope is lightweight, easy to handle, and won't rattle in a cargo box. Easily attaches to the winch cable for an additional 50' of distance. 4,000 lb. single line capacity. **PN 69069**



WINCH MOUNTING SYSTEMS

ENGINEERED FOR OPTIMUM PERFORMANCE.

WARN winches and WARN ATV mounting kits are engineered together as a system to provide maximum pulling power while withstanding the stresses encountered in winching operations.

WARN mounting systems bolt directly to the ATV's structure – no cutting or fabrication is required. During winching, the combination of a WARN winch and WARN mounting kit distributes the weight of the pulling load throughout the ATV's frame, providing extra stability and minimizing the possibility of damaging the ATV or affecting its ride and handling.

Together as a system, WARN winches and mounting kits are field tested to full winch capacity to provide the best performance standards in the industry and give you the results you expect.

All mounting hardware and instructions are included.

Choose the mount that's right for you. Warn offers a range of options, from the internal fixed winch mount, to the versatile Multi-Mount portable winch mounting system.

STATE OF THE ART ENGINEERING AND MANUFACTURING TECHNOLOGY

WARN engineers use computer-aided measuring and design tools to insure the WARN mounting kit fits the specific make and model of your ATV. The mounting kits are then laser cut to the exact dimensions of the ATV, shaped on a computer controlled press brake, and robotically welded for consistent results.

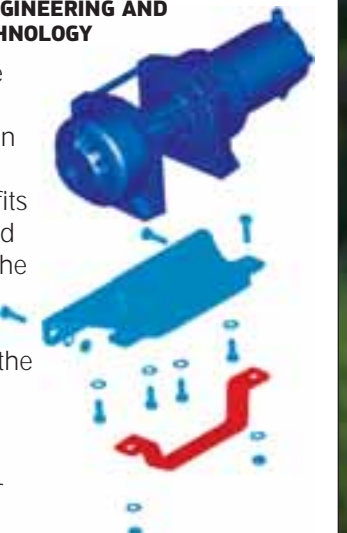
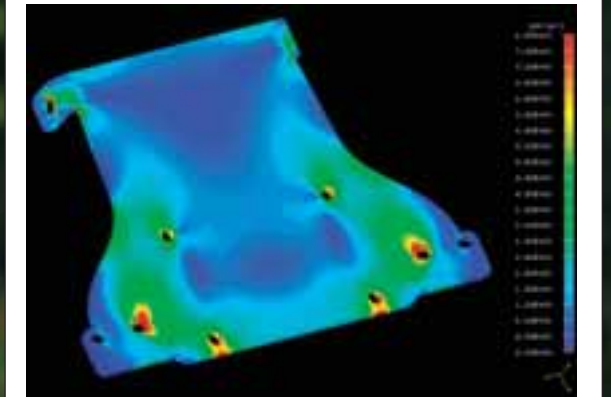

RT/XT 25 AND 30 WINCH MOUNTING KITS

BRP TRAXTER



BRP 800 OUTLANDER



HONDA RUBICON



YAMAHA GRIZZLY



HONDA 400 EX



HONDA 250 EX



HONDA 450R



KAWASAKI KFX 700



HONDA RANCHER



KAWASAKI BRUTE FORCE



KAWASAKI PRAIRIE



YAMAHA KODIAK



POLARIS PREDATOR



POLARIS OUTLAW
Includes integrated bumper with winch mount



SUZUKI SPORT 400



SUZUKI KING QUAD



SUZUKI QUAD RUNNER



POLARIS SPORTSMAN



WARN WINCH KIT FOR THE POLARIS SPORTSMAN



- For pre-wired Polaris Sportsman
- Winch/Mount combo
- Fully pre-assembled and ready to go
- Install time of less than 20 minutes
- WARN RT30 winch
- Patent-pending disc brake
- Mount, roller fairlead, rocker switch and bracket
- Special contactor to mate with the Polaris pre-wire
- Additional wiring and conduit
- Hand-held remote sold separately

PN 75630

SUZUKI OZARK



YAMAHA RAPTOR



YAMAHA WARRIOR 350



TO ORDER THE RIGHT KIT FOR YOUR ATV:

Part numbers are listed on the master application chart in the center of this catalog.

Warn Industries is constantly developing new applications. If you can't find your bike listed there, call WARN Customer Service for the latest applications. In North America call 1-800-543-9276. Customers outside of North America can call 1-503-722-3008. Or check our web site: www.warn.com

RT/XT15 WINCH MOUNTING KITS

Warn Industries offers a winch mounting kit for most popular sport and light utility ATVs.

These kits are designed to accept winch loads of up to 1,500 lbs and should only be used to mount the WARN RT/XT15 winch.

Some sport quad mounts include an integrated bumper to enhance the appearance of your ride while adding protection.

TO ORDER THE RIGHT KIT FOR YOUR ATV:

Part numbers are listed on the master application chart in the center of this catalog.

MULTI-MOUNT

ULTIMATE FLEXIBILITY FOR MOUNTING YOUR WINCH

Winch from the front or the rear of your ATV or UTV, or from vehicle to vehicle. The WARN Multi-Mount winch carrier fits into the front or rear receiver. To move the winch, simply unplug the Quick Connect power leads, pull the hitch pin, and plug the winch into its new location.



Power is supplied through the Quick Connect plug

Mounts easily to the front or rear receiver hitch



Winch is mounted to a steel carrier plate, which can be mounted front or rear

























FRONT MOUNT

The Multi-Mount winch for ATVs is designed to mount to front and rear 1-1/4" Class I receivers. These mounting receivers are engineered for specific ATV makes/models and tie into the ATV frame for increased strength and reliability. Part numbers are listed on the master application chart in the center of this catalog.

HOW TO ORDER – YOU'LL NEED FOUR ITEMS: 1.) WINCH 2.) WINCH CARRIER 3.) QUICK CONNECT WIRING KIT 4.) MOUNTING KIT

See the chart below and choose the set of parts that are right for you.

ATV	MULTI-MOUNT ACCESSORIES/REPLACEMENT PARTS		
	XT/RT30 OR 25 WINCH MOUNTED TO A 1-1/4" RECEIVER:		
	<p>1 Choose a XT/RT25 or 30 winch.</p> 	<p>POWER LEADS WITH QUICK CONNECT PLUG 50 amp—for use with RT/XT 25 and 30 winches: PN 70939 (20" winch lead) PN 72886 (48" battery lead) PN 72888 (96" battery lead) PN 70927 (120" battery lead) PN 22681 (Quick Connect plugs only)</p>	
	<p>2 Winch carrier designed to fit 1-1/4" receiver. PN 70925</p> 	<p>175 amp—for use with RT40 winch: PN 36080 (28" winch lead) PN 70926 (48" battery lead) PN 26405 (90" battery lead) PN 70717 (120" battery lead) PN 22680 (Quick Connect plugs only)</p>	
	<p>3 50 amp Quick-Connect wiring kit for both front and back of vehicle. Includes: 20" winch lead, 36" front battery lead and 96" rear battery lead. PN 70918</p> 	<p>STEEL RECEIVER SHACKLE BRACKET Utilizes a 1-1/4" Class I receiver as a recovery or pulling point PN 62041 (Includes bracket, hitch pin and shackle). PN 28884 (Shackle only)</p>	
<p>4 1-1/4" receiver mounts are vehicle specific. Front and rear mounts are included in each kit. See app chart in center of catalog for part number.</p> 	<p>DUST CAPS FOR QUICK CONNECT PLUGS PN 60917 for 50 amp plug PN 69847 for 175 amp plugs</p>		
	RT40 WINCH MOUNTED TO A 2" RECEIVER:		
	<p>1 RT40 winch.</p> 	<p>RT/XT 30 OR 25* WINCH MOUNTED TO A 2" RECEIVER:</p> <p>1 Choose a RT/XT 30 or 25 winch.</p> 	
	<p>2 Winch carrier designed to fit 2" receiver. PN 70919</p> 	<p>2 Winch carrier designed to fit 2" receiver. PN 70917</p> 	
	<p>3 175 amp Quick-Connect wiring kit for both front and back of vehicle. Includes: 20" winch lead, 48" front battery lead and 120" rear battery lead. PN 70920</p> 	<p>3 50 amp Quick-Connect wiring kit for both front and back of vehicle. Includes: 20" winch lead, 48" front battery lead and 120" rear battery lead. PN 70928</p> 	
<p>4 2" receiver mounts are vehicle specific. Front and rear sold separately. See application chart in center of catalog for part number.</p> 	<p>4 2" receiver mounts are vehicle specific. Front and rear sold separately. See application chart in center of catalog for part number.</p> 		
		RT/XT 30 OR 25* WINCH MOUNTED TO A 1-1/4" RECEIVER:	
		<p>1 Choose a RT/XT 30 or 25 winch.</p> 	<p>1 Choose a RT/XT 30 or 25 winch.</p> 
		<p>2 Winch carrier designed to fit 1-1/4" receiver. PN 70925</p> 	<p>2 Winch carrier designed to fit 1-1/4" receiver. PN 70925</p> 
		<p>3 50 amp Quick-Connect wiring kit for both front and back of vehicle. Includes: 20" winch lead, 48" front battery lead and 120" rear battery lead. PN 70928</p> 	<p>3 50 amp Quick-Connect wiring kit for both front and back of vehicle. Includes: 20" winch lead, 48" front battery lead and 120" rear battery lead. PN 70928</p> 
		<p>4 1-1/4" receiver mounts are vehicle specific. Front and rear mounts are included in each kit. See app chart in center of catalog for part number.</p> 	<p>4 1-1/4" receiver mounts are vehicle specific. Front and rear mounts are included in each kit. See app chart in center of catalog for part number.</p> 

* Warn Industries recommends the RT/XT30 or RT40 winch as the best choice for Utility Vehicles



WARN BUMPERS

EXTRA PROTECTION FROM TRAIL HAZARDS.

WARN bumpers are designed for double duty: protect your ATV or UTV and enhance its appearance. Made of laser-cut steel and powder-coated to resist corrosion, our bumpers provide extra defense against trail hazards and are contoured to give your rig a bold, customized look. Special cutouts on many ATV models can house WARN Trail Lights. They're also fully-compatible with WARN winches, winch mounting systems and plow systems.



HONDA RANCHER



KAWASAKI BRUTE FORCE



KAWASAKI PRAIRIE 700



POLARIS SPORTSMAN*



SUZUKI VINSON



SUZUKI KING QUAD



SUZUKI QUAD RUNNER



YAMAHA KODIAK



YAMAHA GRIZZLY



HONDA RUBICON



HONDA RINCON



ARCTIC CAT PROWLER



THE WARN UTV BUMPER provides the ultimate in versatility and durability. The integrated winch mount allows you to install a WARN winch; pre-drilled holes let you mount WARN Trail Lights; and the bumper folds down allowing the hood to open. The robust construction and a powder-coated wrinkle finish ensure this bumper is built to last.



MANY WARN ATV BUMPERS feature special cutouts and brackets to cleanly incorporate a set of WARN Trail lights (lights are sold separately, see page 32).

TO ORDER THE RIGHT KIT FOR YOUR ATV OR UTV:

Part numbers are listed on the master application chart in the center of this catalog.

Warn Industries is constantly developing new applications. If you can't find your bike listed there, call WARN Customer Service for the latest applications. In North America call 1-800-543-9276. Customers outside of North America can call 1-503-722-3008. Or check our web site: www.warn.com

* Combo bumper winch mount

WARN BODY ARMOR

PUSH THE LIMITS WITH THE ULTIMATE IN PROTECTION AND STYLE.

Warn Industries' line of Body Armor lets you push the limits by giving your ATV and UTV the ultimate in protection and style. The WARN A-Arm Guards and Skid Plates are made from aircraft-grade aluminum for outstanding durability and great looks. The Armor features reinforcing beads for the ultimate in strength, recessed hardware to keep nuts and bolts safe and secure, and holes for drainage and servicing your ATV. Additionally, our super-strong UTV Rock Sliders will protect your vehicle's sides from large objects like rocks and stumps. WARN Body Armor lets you take your mind off damaging your vehicle, and lets you focus on riding. When you want the best in powersports vehicle protection and style, install WARN Body Armor.



MANUFACTURED FROM AIRCRAFT-GRADE ALUMINUM WITH RECESSED HARDWARE FOR GREAT LOOKS AND OUTSTANDING DURABILITY

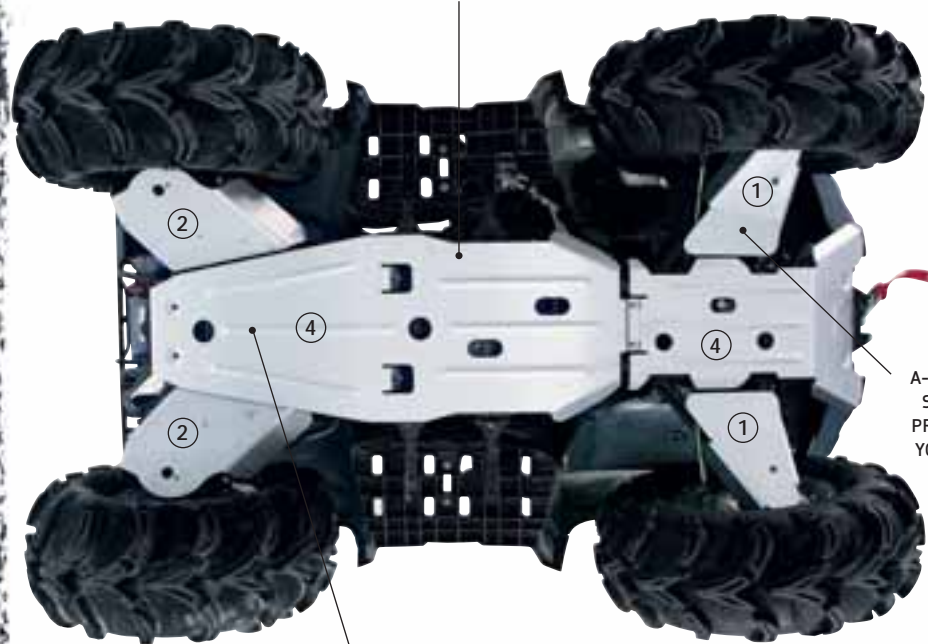

A-ARM GUARDS AND SKID PLATES ADD PROTECTION WHERE YOUR ATV NEEDS IT THE MOST

REINFORCING BEADS ALONG CRITICAL AREAS ADD EXTRA STRENGTH

WRAPS TO HELP PROTECT SIDES OF VEHICLE

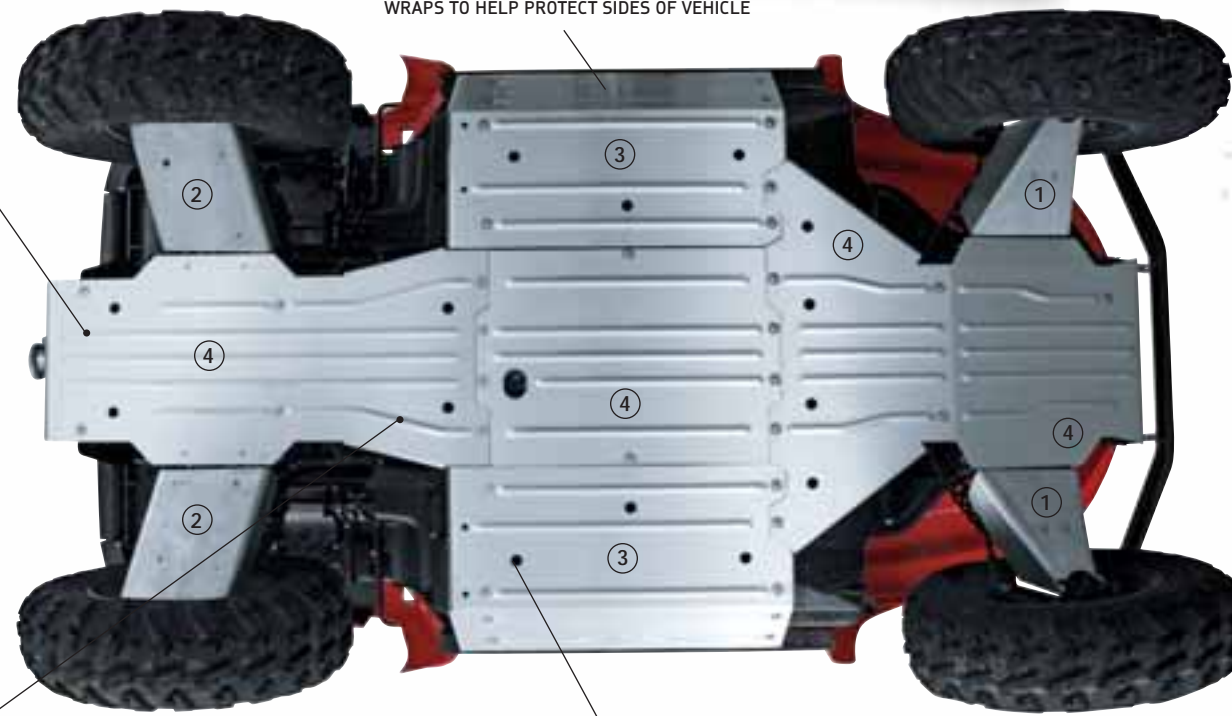

DRAINAGE AND SERVICE HOLES LET MUD AND WATER LEAVE THE VEHICLE AND STILL ALLOW YOU TO MAINTAIN YOUR ATV OR UTV.

WARN UTV ROCK SLIDERS

- Protects the sides of your UTV against large objects such as rocks or stumps
- Quick and easy bolt-on installation
- Made from thick .120 wall steel tubing for outstanding protection
- Powder-coated wrinkle finish is durable and looks great

BODY ARMOR COMPONENTS

- ① A-Arm Kit, Front
 - ② A-Arm Kit, Rear
 - ③ Side Chassis Kit
 - ④ Chassis Kit
- Yamaha Grizzly and Arctic Cat Prowler shown at left. Actual dimensions, beads, and holes will vary for specific vehicles.

TO ORDER THE RIGHT KIT FOR YOUR ATV OR UTV:

Part numbers are listed on the master application chart in the center of this catalog.

Warn Industries is constantly developing new applications. If you can't find your bike listed there, call WARN Customer Service for the latest applications. In North America call 1-800-543-9276. Customers outside of North America can call 1-503-722-3008. Or check our web site: www.warn.com

ATV PLOW SYSTEMS

DESIGNED TO WORK SEASON AFTER SEASON

When your job calls for a reliable, versatile plow system, look no further than Warn Industries. Engineered as a system for durability and maximum performance, WARN plows feature integrated design elements that make your work easier. Our plows feature high-strength steel blades with reinforced ribs for outstanding durability. You can rotate the plow blade up to 25° using either a manual pivot with a five angle position adjustment, or our new electric Power-Pivot that moves the blade at the push of a button without leaving your vehicle's seat.

Rotate the plow blade from the comfort of your vehicle's seat with the new Power-Pivot.



NEW!

POWER-PIVOT

The WARN Power-Pivot lets you rotate your plow blade up to 25° at the push of a button, and without having to get up from your vehicle's seat. A powerful electric motor and durable 4-stage planetary geartrain lets you move a load, even while plowing. The unique locking design isolates the geartrain preventing slippage and creep under load. Plus, when necessary, the blade can still be positioned manually. The Power-Pivot will fit any WARN plow – old or new.

- Color-coded wiring for quick and easy assembly on WARN Plow Base.
- When using the Power-Pivot, you must use a winch for plow lifting.

Not for use with Universal Manual Plow Lift or ATV Plow Actuator.

PN 73860

BLADE ANGLE ADJUSTMENT: MANUAL OR POWER OPTIONS

- Our manual plow pivot lets you quickly move the blade to five different positions without tools. The Power-Pivot allows you to turn the blade at the push of a button with a handlebar-mounted control switch.



ENGINEERED FOR MAXIMUM DURABILITY

- Unlike other plows, which use a single pivot bolt, WARN plows rotate on a 6" diameter bushing plate. Shock loads are distributed across the entire plate rather than concentrated in a small area. This results in long life and increased performance.

MOUNTING BRACKET

- Plow mounting bracket is attached high on the frame and positioned near the front axle for better ground clearance and increased rigidity.
- Plow can be removed or switched to another ATV in seconds with the WARN quick-release design. No tools required.

FORWARD PIVOT

- Blade pivots forward when striking an unmoveable object, helping to protect the plow assembly from damage

PLOW LIFT

- 11-1/2" with a winch lift or 8" with the manual lift. High enough for the tallest curbs.
- Lift the plow with your WARN Winch, Plow Actuator or the Universal Manual Lift



BLADE DESIGN

- Thick blade ribs tie into a boxed blade support, providing maximum structural support
- Engineered plow design provides strength and durability while also minimizing weight – the result is a better handling ATV

WEAR PARTS

- Wear bar provides 1" of wear before needing replacement. The bar for the 60" blade is reversible – providing double the wear material.
- Long lasting, heavy-duty gravel skids are adjustable with quick-release pins. No tools required.



HOW TO ORDER YOUR WARN ATV PLOW SYSTEM

Select the part numbers for: 1) Plow blade. 2) Plow base assembly. 3) Mounting plate assembly. 4) Plow blade-raising mechanism.

1.) CHOOSE YOUR PLOW BLADE



WARN CYCLONE ANGLED PLOW BLADE

- Tapered design and aggressively curved profile steer snow or dirt up and away from the surface you're clearing.
- Made from heavy-duty 11-gauge steel backed up by extra-heavy ribbing.
- Durable powder coat yellow finish.
- Heavy-duty skid plates are made of 1/4" gauge steel with zinc finish.
- Comes with replaceable steel wear bar.
- Available in 54" or 60" widths.

PN 68710 54" Cyclone Blade
PN 68200 60" Cyclone Blade



STANDARD PLOW BLADE

- Made from 14 gauge high-strength low alloy steel with 3/16" outer blade ribs to provide superior strength and rigidity.
- Blade height is 16-3/16".
- Durable black powder coat finish.
- Comes with replaceable steel wear bar.
- Now includes heavy-duty skid plates made of 1/4" gauge steel with zinc finish.
- Available in 48", 54" or 60" widths.

PN 70948 48" Standard Blade.
PN 70954 54" Standard Blade.
PN 70960 60" Standard Blade.

REPLACEMENT PARTS FOR PLOW BLADES:

48" steel wear bar: **PN 39416**
54" steel wear bar: **PN 39415**
60" steel wear bar: **PN 62601**

Premium skids (for Cyclone and Standard Blade PN 70948, PN 70954 and PN 70960) **PN 69212**

Standard skids (for Standard Blade PN 37574, PN 38732 and PN 38121) **PN 38330**

2.) ORDER THE PLOW BASE

PLOW BASE/TUBE ASSEMBLY

- Universal design. One part number fits all WARN ATV plow blades and mounting kits.
- Oversize bushings dramatically reduce wear and absorb the shock of plowing.
- Durable black powder coat finish

PN 62100 Fits all ATV plow blades and mounting kits

POWER-PIVOT

- Bolts to plow base assembly
- Electrically pivot your plow blade at the touch of a button from the comfort of your seat.
- Powerful motor with 4-stage planetary geartrain can turn blade up to 25°, even under load and without slipping.
- Color-coded wiring for quick and easy assembly on WARN Plow Base
- When using the Power Pivot, you must use a winch for plow lifting.

PN 73860 Not for use with Universal Manual Lift or ATV Plow Actuator.

3.) PICK YOUR PLOW MOUNTING KIT

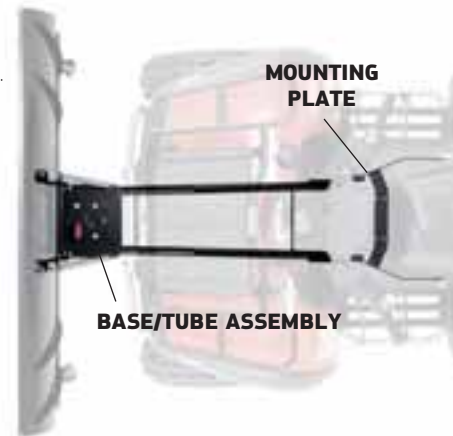

WARN ATV PLOW MOUNTING KIT

- Mounting plate remains attached to the ATV and becomes a structural component adding rigidity to the ATV during plowing operations.
- Designed for high ground clearance and quick plow installation or removal.
- Placement is forward of the foot pegs to avoid any reduction of ground clearance or operating interference.
- Quick release pins attach or detach the plow blade and base assembly in a matter of moments.

PART NUMBERS: Each kit is engineered to fit a specific ATV make and model. Applications are listed on the master application chart in the center of this catalog.

4.) PICK YOUR BLADE RAISING MECHANISM

You have three choices of how you can raise and lower your WARN Blade: actuator, manual lift or winch.

ATV PLOW, ELECTRIC ACTUATOR

- Designed with a dual purpose in mind: to lift the plow without manual effort, and leave the winch for what it was designed to do.
- Pulling capacity is more than enough power to reliably lift the heaviest blade.
- Actuator will operate only with the ignition on and comes standard with a thermal limiting switch. The limiting switch eliminates the possibility of damage to the ATV, plow or Actuator.

- All-weather, handlebar mounted switch can be operated without removing your hand from the grip.
- Easy to install kit that fits all WARN plows. Kit includes a handlebar switch, wiring harness, cable termination strap, and all necessary hardware.



PN 67650

UNIVERSAL CABLE TERMINATION STRAP

Plow Actuator kit includes the cable termination strap. Universal design eliminates the need for the pulley bracket. Easy on and off.

REPLACEMENT PARTS FOR ATV PLOW ACTUATOR PN 67650:

- Switch kit **PN 69660**
- Motor **PN 68167**
- Wiring harness with relays **PN 68194**
- Relays **PN 66510**
- Wire rope **PN 68135**
- Termination Strap **PN 68191**

WARN UNIVERSAL MANUAL LIFT

- Delivers maximum lifting power with a minimum of effort.
- Lever-style arm requires minimal force to lift the blade, reducing operator fatigue.
- Overall lift height is 8 inches or more, so you can clear obstacles like curbs.
- Lift is easily detached along with the entire plow/arm assembly, freeing the ATV for other uses.
- Built of durable powder coated steel and zinc plated hardware.

PN 65510 For use with WARN plow kits only

Replacement parts :

- Bushings and spacers **PN 68169**
- Wire ropes **PN 68171**
- Brake cable **PN 68193**
- Termination Strap **PN 68191**
- Ratchet and pawl kit **PN 69268**

XT15, 25 OR 30 WINCH

- An excellent choice if you want a multi-use piece of equipment.
- For durability, the WARN synthetic rope and/or plow roller fairlead is strongly recommended.



NEW!

UTV PLOW SYSTEMS

UNIQUE SYSTEM PROVIDES EASY
BLADE CONNECT AND DISCONNECT



Unique drive-up system allows for quick connect and disconnect of the plow, and does not require a driver to crawl under the vehicle. No tools required.



The UTV Plow System is designed to use a WARN winch as the plow lifting mechanism. Winch sold separately.

*03-06 YAMAHA RHINO

Plow Mounting Kit:
PN 70985

Blade Kit (choose one):
PN 70935 66",
PN 71920 72"

Plow base kit:
PN 70990

*02-06 POLARIS RANGER

Plow Mounting Kit: **PN 71330**
Blade Kit (choose one): **PN 70935** 66", **PN 71920** 72"
Plow base kit: **PN 70990**

* Note: winch mount sold separately

The WARN Utility Plow system features a unique and exclusive design that allows for quick connect and disconnect of the self-standing plow, and does not require a driver to crawl under the vehicle or manually lift the blade. The system lifts the plow blade straight up and down and creates over eight inches of raised height.

The WARN Utility Plow system features a heavily-reinforced steel blade available in a 14-gauge, 66-inch width or an 11-gauge, 72-inch width. Heavy-duty adjustable gravel skids with quick release clips come standard, as does a replaceable steel wear bar for added durability.

Impact tested for maximum durability, the system contains no under-chassis hardware that could be damaged during regular vehicle usage.

Mounting system works with the existing frame of the vehicle – no modification is necessary. Designed to use a WARN winch as the plow lifting mechanism – winch sold separately.

Current applications available for the Kawasaki Mule, Polaris Ranger, and Yamaha Rhino.



*02-06 KAWASAKI MULE

Plow Mounting Kit: **PN 71983**
Blade Kit (choose one): **PN 70935** 66", **PN 71920** 72"
Plow base kit: **PN 70990**

PLOW ACCESSORIES

BOLT ON MORE EFFICIENCY

WARN already leads the way with ATV plow systems, from blade to lifting mechanism. We've rounded up the products you see here to further enhance the WARN ATV plow system.

Here are eight products our customers have not only asked for, they flat out need. Each accessory is designed to either save you time, money, hassles—or all three. Combine them with your WARN Plow and you'll have an even more versatile and productive tool.



NEW!

POWER PIVOT

Move your plow blade up to 25° at the push of a button with this powerful electric pivot. For use with WARN Plow Base/Tube Assembly.

PN 73860 Not for use with Universal Manual Lift or ATV Plow Actuator

ATV PLOW MARKERS

- 2' high antenna
- Red rubber tipped for visibility
- Clearly mark the edge of your plow blade, even in deep snow
- Easy, bolt-on mounting

PN 67679

SNOW CONTROL FLAP

- Flexible rubber top flap
- Controls snow kickback-keeps snow on the ground, out of your face
- Fits all WARN plows (cut to size)

PN 67870 (60")

BLADE SIDE WALL

- Controls run off, and gives you scoop-like control of snow, and other materials
- Lets you gather material before depositing to the side
- Heavy duty steel construction
- Reversible, can be mounted on either side
- Good for snow or ag applications

PN 70880 (for Cyclone and Standard Blade PN 70948, PN 70954 and PN 70960)

PN 67957 (for Standard Blade PN 37574, PN 38732 and PN 38121)

PN 71320 (for UTV blade)

HEAVY-DUTY SKID UPGRADE KIT

- Upgrade your Standard plow skids to these heavy-duty skids
- Heavy duty 1/4" gauge steel with zinc finish

- Quick release pins make adjustments easy

PN 69073 (for Standard Blade PN 37574, PN 38732 and PN 38121)



PLOW LIFT ROPE

- 8' section of durable, super-strong synthetic rope
- Temporarily replace your wire winch rope for plow season, saves wear and tear
- Stands up to repeated, sharp angle pulls used to lift heavy plow blade

PN 68560



ROLLER FAIRLEAD FOR ATV PLOW

Designed for use with winches that raise and lower the ATV plow blade. Larger diameter lower roller reduces wear on wire rope.

PN 69373



PLASTIC WEAR BAR

- Ultra high molecular weight plastic (UHMW).
- Reversible—just flip it when worn
- Saves wear on plow blade
- Excellent for use on concrete/brick
- 3/4" thick

PN 67860 (48") **PN 67861** (54"), **PN 67862** (60")

WARN LIGHTS

CHALLENGE THE DARKNESS AT EVERY TURN.



TRAIL LIGHTS

Created specifically for ATVs, the WARN Trail Lights have a lens design that achieves a 110° beam spread from side to side and a 70° vertical (35° up and 35° down), and use 35-watt, battery-saving H3 halogen bulbs with 400 candlepower. The result is a field of illumination that is wider and higher than factory-installed ATV lights so you get the whole view while you're on the move. **PN 62018**

TRAIL AND BACKUP LIGHTS REPLACEMENT PARTS
Light with bulb (for Trail Light or Backup Light), PN 63816,
Bulb (for Trail Light or Backup Light), PN 63815
Switch (for Trail Light or Backup Light), PN 63814



4X FLOOD LIGHTS

If you're looking for great side visibility, WARN 4X Flood lights have a beam spread of 15° vertical by 24° horizontal. That means you'll have the advantage on the trail particularly in areas where there are deer, elk, livestock, or other frequent surprises. 4X Flood lights are available in 6" and 5" sizes, and feature 55 watt H-3 quartz halogen bulbs, polished stainless steel housings, hard plastic lens covers, and 2-axis mounting brackets.

PN 220522 (5" kit, includes pair of lights, switch, wiring and two hard plastic lens covers)
PN 220622 (6" kit, includes pair of lights, switch, wiring and two hard plastic lens covers)

SDB-160HBE

These dual beam fog/spot lights have an internal light frame to protect the lamp from vibration and shock. Plus, they have a polycarbonate body to protect the exterior. The lens is protected by a V-shaped stone guard to let air cool the lens surface, allowing extended operation. They feature a wide fog beam pattern and 50,000 candlepower, so you can be assured they produce plenty of light. The hardened glass lens has excellent heat and thermal shock resistance, strength and translucency.

PN 60776 (6" diameter, 55-watts)



DUAL BATTERY ISOLATOR

- For vehicles with multiple batteries
- Prevents the problem of multi-battery drain
- Will not drain power from the battery you depend on to start your vehicle's engine **PN 22630** (95 amp rated)

BACKUP LIGHT

When even the most aggressive ATV rider needs to back up, the WARN Back-Up light provides the illumination needed, thanks to a 35-watt, battery-saving H3 halogen bulb. The light uses a universal mounting bracket, and comes with a wiring harness. Designed for ATV use, the light comes with a water-resistant switch and all the necessary mounting hardware. **PN 62017**

H.I.D. LIGHTS

These high-intensity-discharge lights have an amazing 200,000 candlepower to light up the night. At 300 ft., there's an illumination distance of 840 ft. with an 18-ft.-wide beam. These lights are great for powersports use because of the low amp draw. An impact-resistant polycarbonate resin material body is great for durability. **PN 64560** (6" diameter, 35 watts)

424 SELECT

WARN 424 Select is an ATV front-end disconnect system that allows you to manually disengage both front wheels for greater maneuverability then re-engage 4-wheel drive for superior traction. The system was designed specifically for 4-wheel drive Honda, Yamaha and Kawasaki ATVs.

WARN 424 Select is a high-value upgrade that offers increased maneuverability for a sport bike feel and provides reduced steering effort for decreased wear and tear on you and your ATV.

FEATURES:

- Shafts are 4140 alloy heat-treated steel that's nickel plated for superb corrosion resistance.
- Teflon lined control cable reduces friction, makes engagement easy.
- 2-position, manual shift control cable has positive locking that won't vibrate loose.
- Disconnect housing is sealed, requires minimal maintenance.
- Bolt-on installation with standard tools.

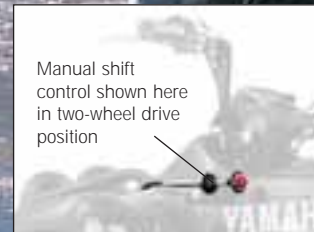

424 Select replacement cable, **PN 63739** 424 Select replacement bearing seal kit, **PN 63743**

FRONT-END DISCONNECT SYSTEM FOR GREATER MANEUVERABILITY.

Each kit is engineered to fit a specific ATV make and model. Applications are listed on the master application chart in the center of this catalog.

Warn Industries is constantly developing new applications. If you can't find your bike listed there, call WARN Customer Service for the latest applications. In North America call 1-800-543-9276. Customers outside of North America can call 1-503-722-3008 or check our website at www.warn.com.

WARN TRUCK AND UTILITY PRODUCTS

Warn Industries means more than just Powersports products. We're also the experts in truck winches and utility products for your shop. Check out these other WARN products that help serve your pulling and lifting needs.

PowerPlant DUAL FORCE HP AND HD VEHICLE-MOUNTED MULTI TOOL

Combines a top-of-the-line air compressor with a legendary WARN winch in one vehicle-mounted unit. Perfect for off-road enthusiasts or contractors.

- Available in 9,500 lb. (HP) and 12,000 lb. (HD) line capacities.
- Powerful compressor is great for airing-up tires, powering air tools, or inflating recreational equipment, such as rafts
- On-board 1/2 gallon air reservoir and intercooler
- Includes 25' of coiled nylon hose, handheld control with thermometric LED, quick-connect couplers, tire gauge, and dual air chucks
- Additional accessories available.



PN 71800 PowerPlant Dual Force HP **PN 71801** PowerPlant Dual Force HD

WARN WORKS® PullzAll™ HANDHELD ELECTRIC PULLING TOOL

Easily lifts or pulls up to 1,000 lbs. Great for pipe lifting, fence pulling, steel working, engine hoisting, and much more

- Variable speed control trigger allows for precise movements
- Ability to stop and hold a load where you want it
- Instantly change directions at the push of a button
- 15' of wire rope
- Available in 110 volt corded or 24 volt cordless versions

PN 685000 Corded 110 Volt
PN 685005 Cordless 24 Volt Rechargeable



For more information on all WARN products, log on to www.warn.com

WARN LIGHT BAR FOR UTVS

- Pre-drilled holes to mount up to four 6" lights
 - Mounts to a UTV's roll cage
 - Black powder-coated wrinkle finish
 - Fold down feature for clearance under obstacles and when hauling
 - See application guide for mounting brackets for your UTV.
- PN 75566**

